

OUTDOOR KITCHEN 32" Cabinet Cover



Warning: Dispose of Polybag immediately

Do not leave children unattended near cabinets.

For assistance, call 1.877.306.8930; for UK 0800.031.4069; e-mail at info@newageproducts.com

65820-INSTL-01-Rev.01

Manufacturer Warranty Limited Lifetime

When this product is installed, operated and maintained according to the instructions attached to or furnished with the product, NewAge Products Inc. will replace the defective product or parts if the part fails as a result of defective materials or workmanship for the Lifetime of the product.

NEWAGE PRODUCTS INC. WILL NOT PAY FOR:

1. Service calls to correct the installation of any NewAge products or to instruct you how to use or install them.
2. Damage resulting from improper handling or shipping of products, or products damaged by accident, misuse, abuse, fire, flood, improper installation, acts of God, neglect, corrosion, modification, mishandling or not following care instructions.
3. Products damaged by improperly loading beyond the specified maximum weight capacity outlined in the instructions provided with the product.
4. Repairs or replacement when your product is used in other than normal, single-family household use, such as a commercial environment, or handled in anyway inconsistent with the installation instructions included with the product.
5. Cosmetic damage, including scratches, dings, dents or cracks in paint that do not affect the structural or functional capability of the product.
6. Surfaces damaged due to chemical interaction resulting in corrosion of paint or metal.
7. Replacement parts for NewAge products outside Canada and the United States, U.K.
8. Loss of product contents due to theft, fire, flood, accident or acts of God.
9. Shipping or freight fees to deliver replacement products or to return defective products.
10. Any labor costs during the limited warranty period.

DISCLAIMER OF IMPLIED WARRANTIES; LIMITATION OF REMEDIES

IMPLIED WARRANTIES, INCLUDING TO THE EXTENT APPLICABLE WARRANTIES OF MERCHANTABILITY OR FITNESS FOR A PARTICULAR PURPOSE, ARE EXCLUDED TO THE EXTENT LEGALLY PERMISSIBLE. ANY IMPLIED WARRANTIES THAT MAY BE IMPOSED BY LAW ARE LIMITED TO ONE YEAR, OR THE SHORTEST PERIOD ALLOWED BY LAW. SOME STATES AND PROVINCES DO NOT ALLOW LIMITATIONS OR EXCLUSIONS ON HOW LONG AN IMPLIED WARRANTY OF MERCHANTABILITY OR FITNESS LASTS, SO THE ABOVE LIMITATIONS OR EXCLUSIONS MAY NOT APPLY TO YOU. THIS WARRANTY GIVES YOU SPECIFIC LEGAL RIGHTS, AND YOU MAY ALSO HAVE OTHER RIGHTS WHICH VARY FROM STATE TO STATE OR PROVINCE TO PROVINCE

NEWAGE
PRODUCTS INC.

Installing the Cover

- 1 Remove 32inch cover from poly bag.
Lay cover on top of cabinet.

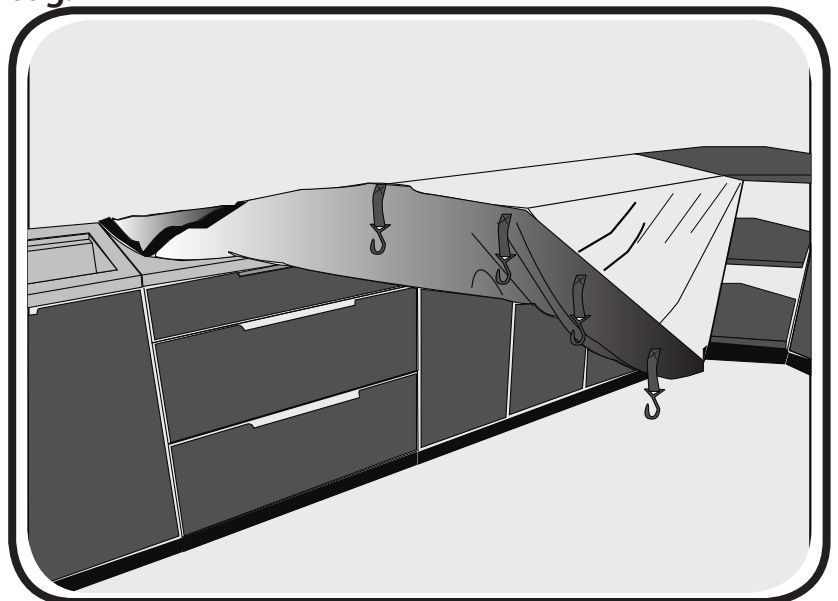

- 2** Make sure that the velcro is on the left side of the cabinet

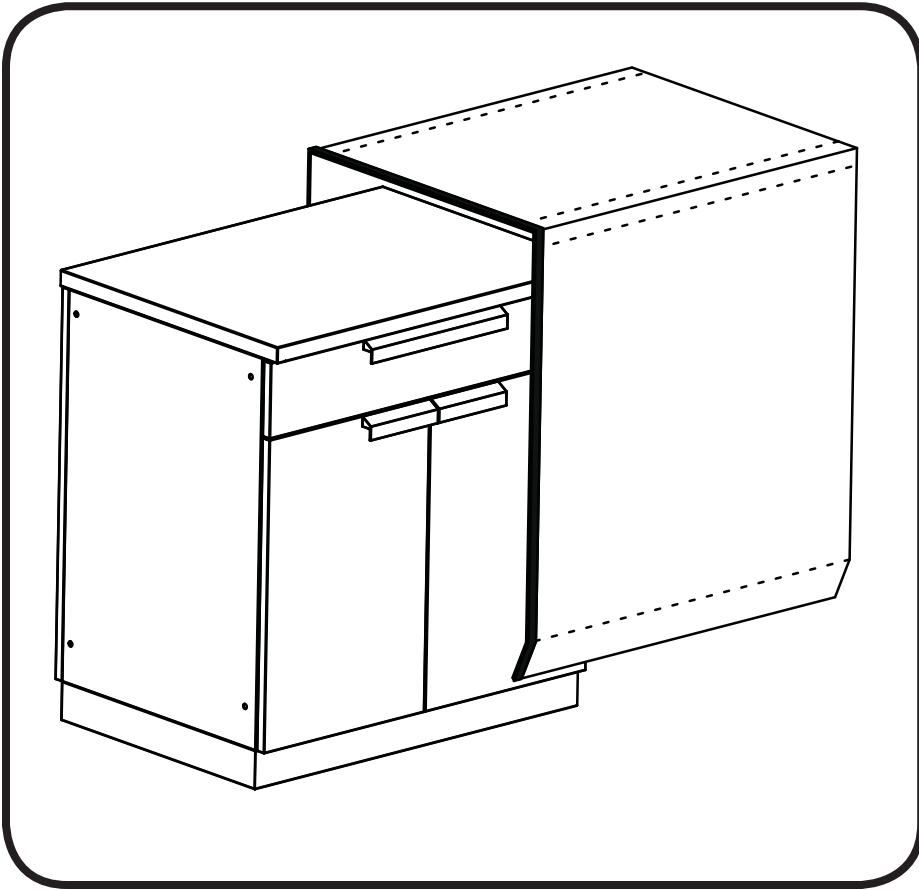

- 3** Slide Cover to the left to align with side of cabinet.

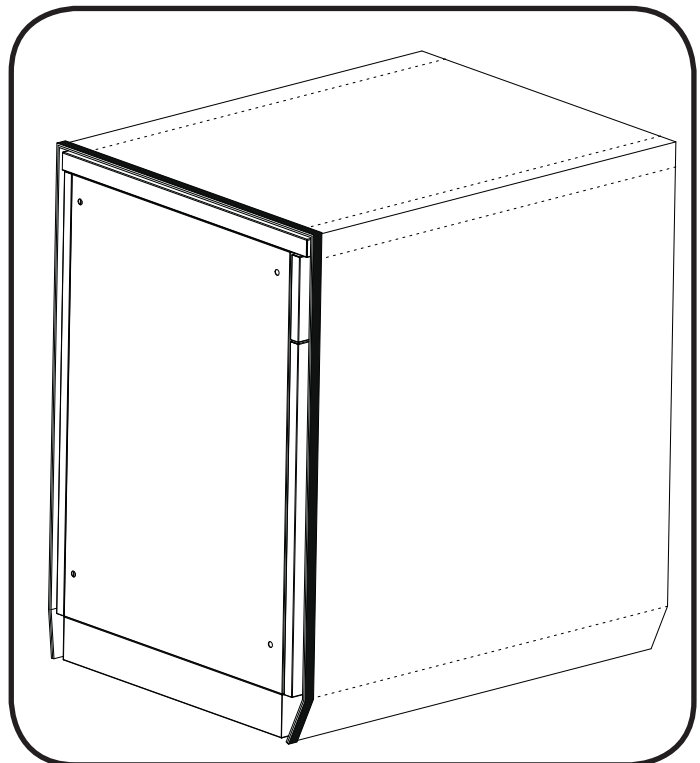

3

Locate 2 hooks on front bottom flap.
Pull down on hook by stretching elastic strap
place hook under kick edge and rotate 90
degrees to engage on kick frame.

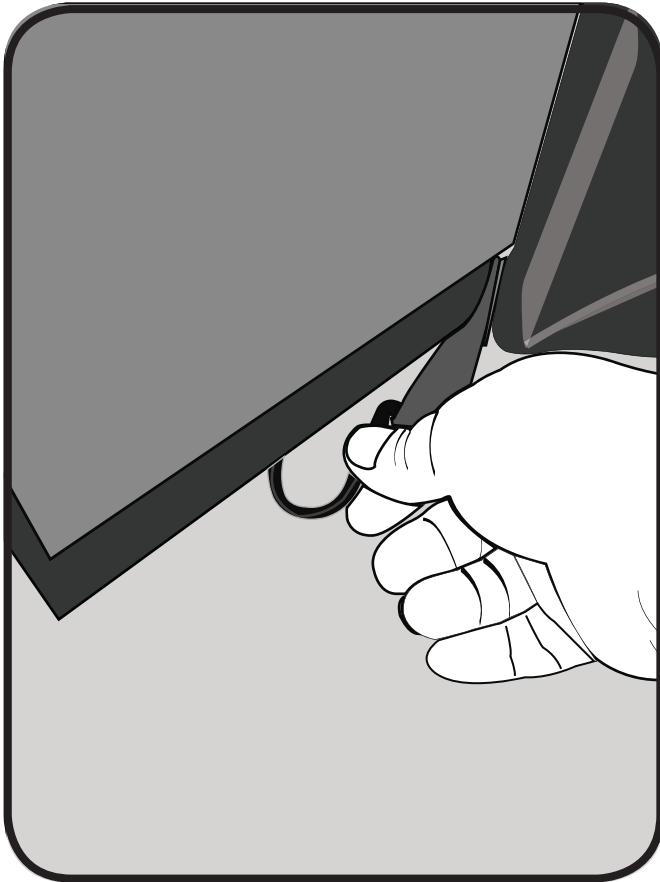

4

Repeat this process for all 4 of the hooks on the
front and rear lower flaps.

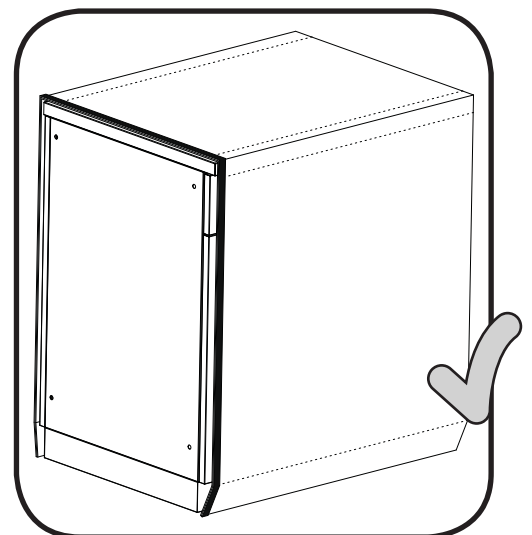
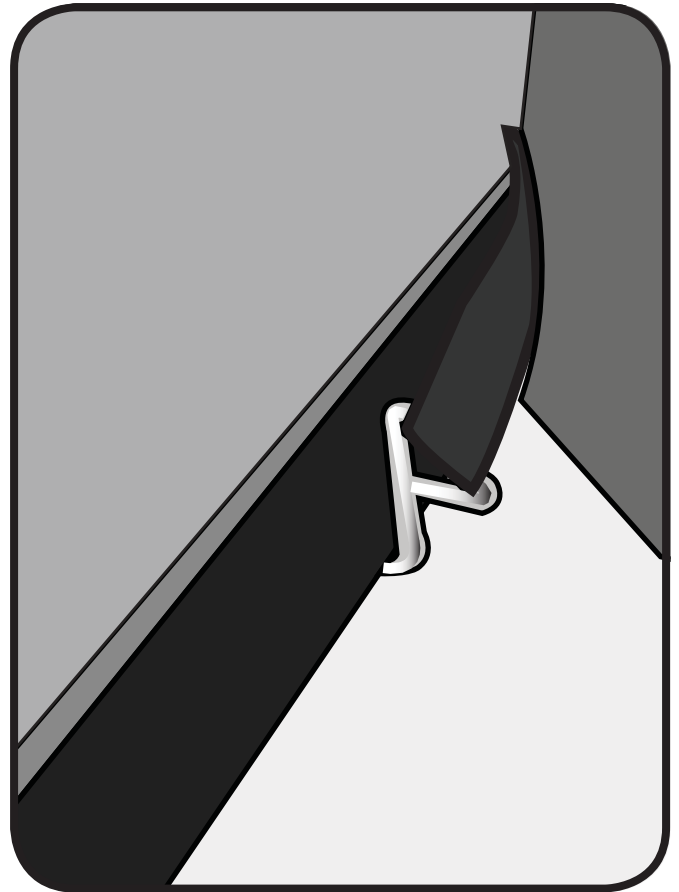

* Optional Side Panels Installation

- 1 Remove Right and Left side panel covers from poly bag. Locate Right panel (loop tape above cover surface) on right side. Locate Left Side panel (Hook tape on underside of panel.)

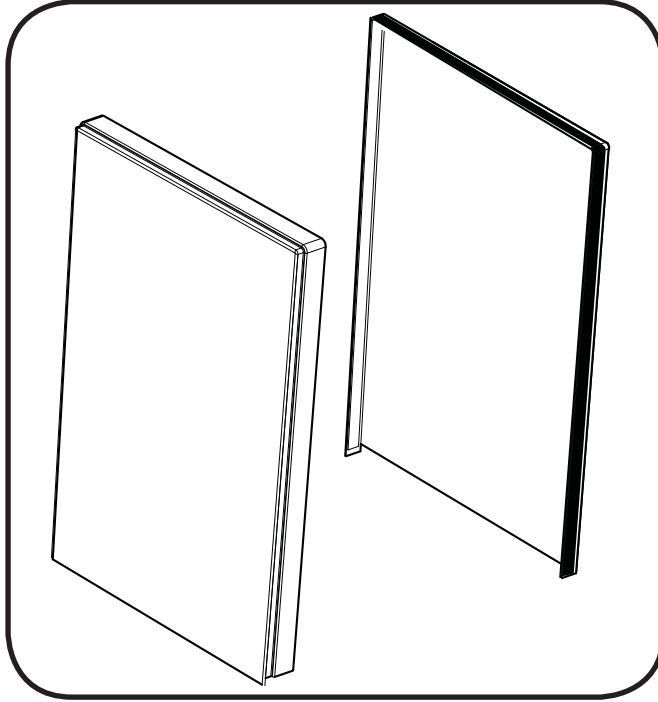

- 2 Left Side Installation; Align top band velcro hook of left side panel with cabinet's left side exposed velcro loop seam . Continue aligning and fastening front and back upright seams.

Right Side Installation; Insert top band velcro loop of Right side panel underneath cabinet's right side velcro hook seam . Continue aligning and fastening front and back upright seams.

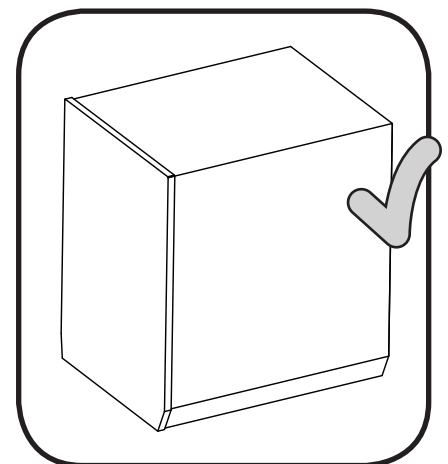
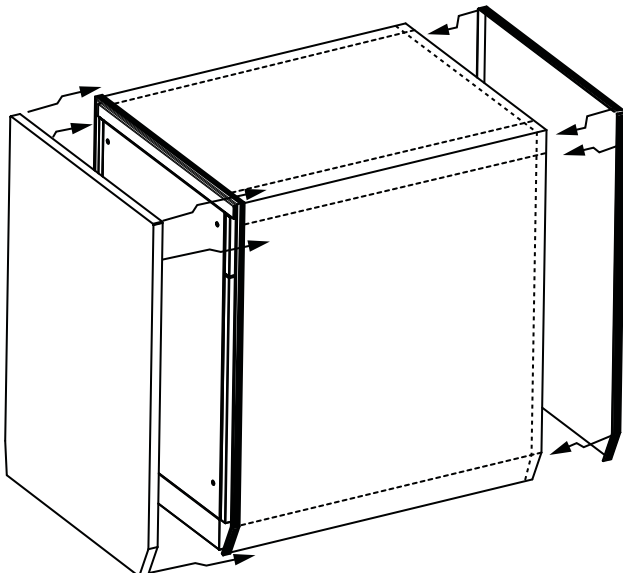

* Optional Connecting Panels Installation

- 1 Overlay Velcro seam (hook) of left cabinet cover on top of right cabinet cover (loop) seam. Continue to attach Velcro seams together on front and back of covers.

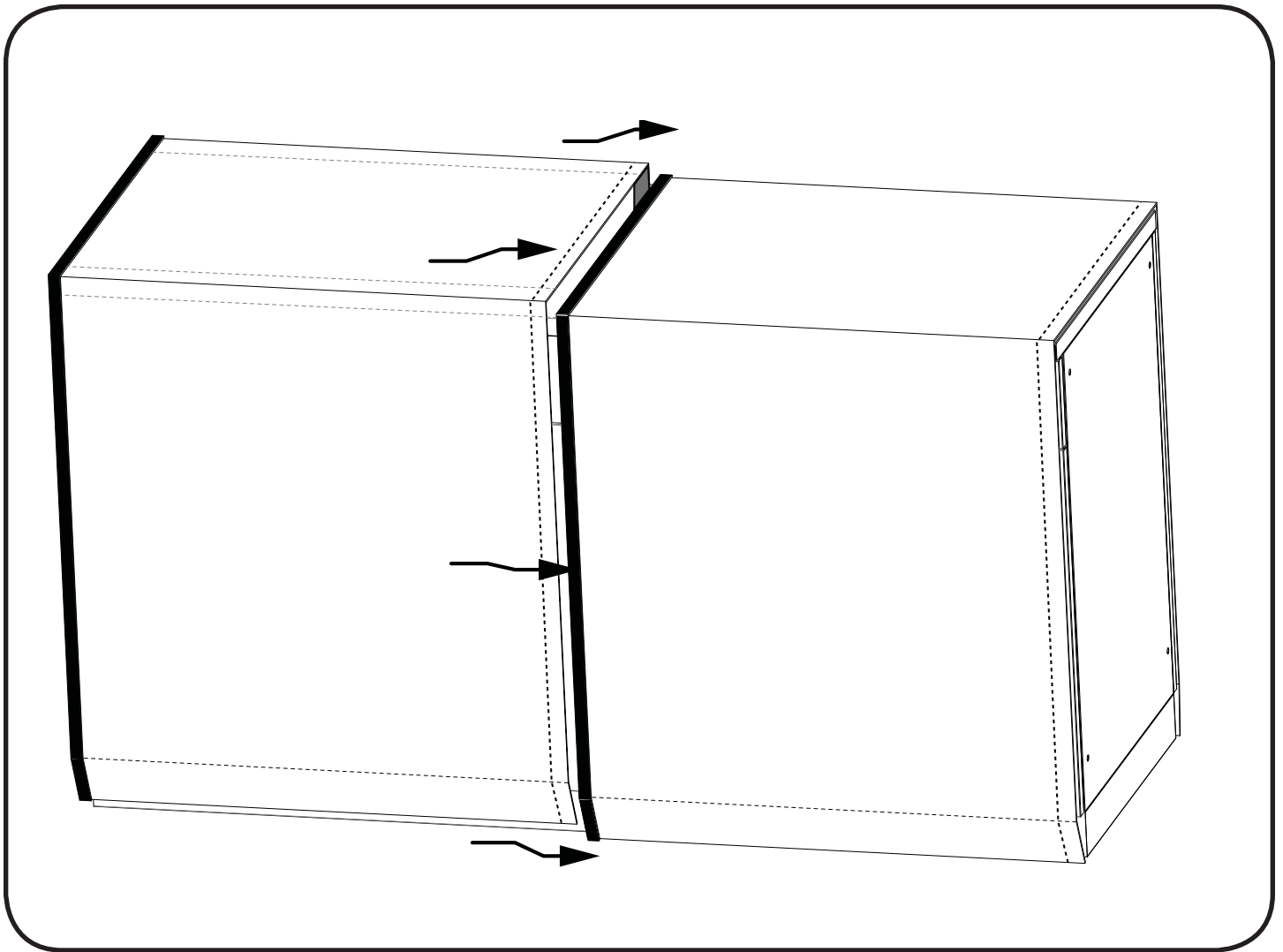

Care and Maintenance of your Polyester Covers

Perform Regular Maintenance

List of common conditions that cause discoloration of polyester Covers and should be avoided:

- 1. Chloride containing cleansers – this includes bleach and any cleaners containing bleach**
- 2. Muriatic acid (hydrochloric acid) – commonly used to clean up after tile/concrete installation**
- 3. Concentrated soap residue – chemical additives will cause discoloration and some dried soaps actually look like soil**
- 4. Water with high iron content – can leave a rusty residue, especially if allowed to drip continuously.**
- 5. Contact with iron materials – including steel wool, iron residue/dust from installation or cleaning of other steel products**
- 6. Trapped moisture between the product and cover – rubber mats, metal cans or cleaner cans- Allow cabinets to completely dry before covering.**
- 7. Salts – contain chlorides**
- 8. Extreme Heat by Flame**
- 9. Do not permit citrus or tomato juice to remain on stainless steel surfaces.**
- 10. No abrasive cleaners, steel wool pads, or abrasive cloths as they will scratch the finish.**

Light Soil Removal

Wash regularly with clean fresh water, mild detergent and a soft plastic bristle brush. After washing rinse with clean water and hang the covers to dry.

Generally you should wash your covers every 2 months. Coastal areas or next to a chlorine pool more frequently every 2 weeks.

Do not use abrasive cleaners or a scouring pad of any type as they will cause excessive wear and abrade the finish of the covers.

Covers in coastal environments may show white salt powder blotches if not washed regularly.